

OWNERS MANUAL

The Original & Silver Bullet



CENTURIONPRO
ELITE TRIMMING TECHNOLOGIES



cprosolutions.com

1 855 535 0558

info@cprosolutions.com

OWNERS MANUAL

The Original & Silver Bullet



CENTURIONPRO

ELITE TRIMMING TECHNOLOGIES



cprosolutions.com



1 855 535 0558

TABLE OF CONTENTS

Important Safety Information	4
Machine Assembly	5
Cover Assembly	6
Double Bag Kief Collection System	7
Leaf Collector Assembly	8
Hopper Assembly	9
Blade Removal	10
Cleaning the Original & Silver Bullet	10
Leaf Collector Cleaning	11
Machine Maintenance	12
Quantanium Coated Non-Stick Tumbler	13
Warranty Information	14
Frequently Asked Questions	15
Additional Assistance	16
Original & Silver Bullet Machine and Leaf Collector Specifications	17

IMPORTANT SAFETY INFORMATION



IMPORTANT

This document refers to the CenturionPro Solutions Original & Silver Bullet automated trimming systems.

The Original & Silver Bullet are high-speed trimming systems, requiring that specific safety precautions are practiced during operation to reduce the risk of personal injury. Improper use of The Original, Silver Bullet, or any Centurion Pro trimming machine, may cause serious or fatal injury. Please ensure you read the operations manual and warning notes before using the Original or Silver Bullet.

Do not lend out or rent your Original or Silver Bullet without this operating manual. A first time user should obtain proper instruction prior to use.

GENERAL

- Do not move, disassemble, clean or inspect the trimmer while the power is still connected to the machine.
- Replacement parts are specific to The Original & Silver Bullet and must be purchased from an authorized dealer only. Substituting factory parts with non-approved third-party replacements may result in damage to the machine or bodily harm.
- Keep all individuals a safe distance from the work area. Do not operate the machine around children.
- Do not remove safety labels. Replace any and all labels if they become damaged or obscured.

CONNECTION

- As with home appliances, The Original & Silver Bullet must be used in connection with a properly grounded receptacle.
- Never plug in or power up your trimming machine if the protective shrouds are removed.
- Do not use extension cords over 8m (25ft) in length to power the Original or Silver Bullet.

OPERATION

- The initial set up will show assembly instructions to unpack and set-up your machine.
- Your bed bar blade has been factory set to cut perfectly. Please do not adjust your blade until it is time to clean the machine. Also, please watch the video tutorial located on our website on how to adjust your blade before attempting.
- Safety glasses should be worn at all times while operating The Original or Silver Bullet.
- Do not operate any trimming machine while tired or under the influence of medication, drugs or alcohol.
- Do not put anything other than plant material into the tumbler. Doing so may cause damage to the tumbler, the machine or result in bodily harm.
- Operate the trimmer in a well ventilated area in order to prevent overheating.

MAINTENANCE

- Never leave The Original or Silver Bullet system running unattended.
- Never conduct maintenance or cleaning while the machine is plugged in.
- Do not modify or adapt any part of the trimmer or its accessories. Doing so may cause irreversible damage to the machine or result in bodily harm.



CENTURIONPRO

ELITE TRIMMING TECHNOLOGIES



cprosolutions.com



1 855 535 0558

MACHINE ASSEMBLY

110V North America
220V Australia EU



TOOLS REQUIRED

- | | | | |
|-----------|-----------------------|-----------|-----------------------|
| 1 x #2 | Phillips Screwdriver | 1 x 1/8" | T-Handle Allen Wrench |
| 1 x 3/32" | T-Handle Allen Wrench | 1 x 3/16" | T-Handle Allen Wrench |
| 1 x 5/32" | T-Handle Allen Wrench | 1 x 3/8" | Wrench |

COVER ASSEMBLY

It is UNSAFE to operate the ORIGINAL or SILVER BULLET TRIMMER without COVERS!

STEP 1

Attach the BEARING COVER to the ORIGINAL or SILVER BULLET

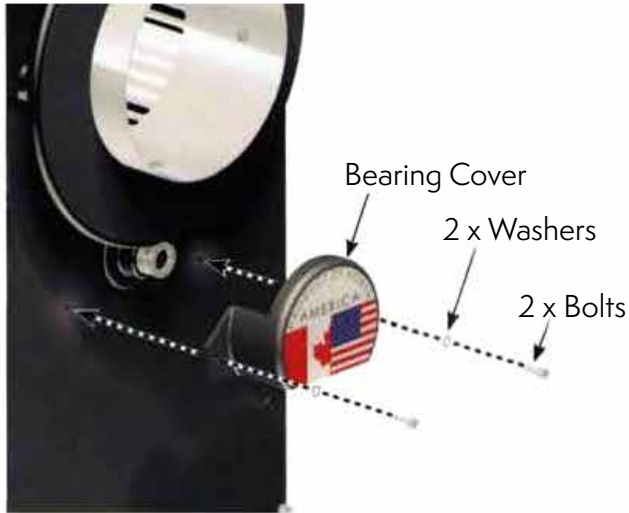

STEP 2

Attach the BELT COVER to the ORIGINAL or SILVER BULLET

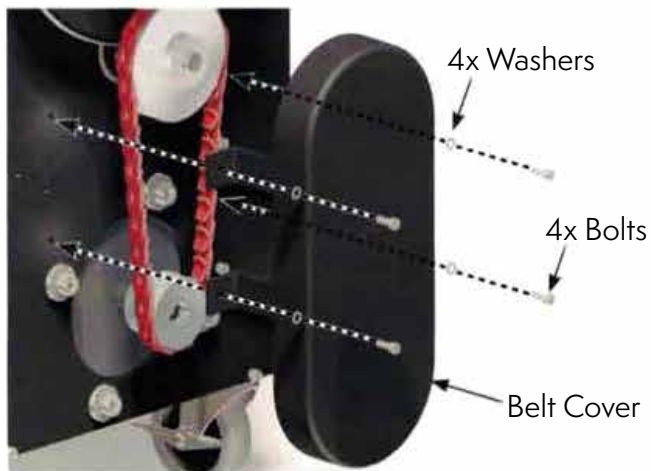

CENTURIONPRO

ELITE TRIMMING TECHNOLOGIES



DOUBLE-BAG KIEF COLLECTION SYSTEM

Kief is becoming wildly popular due to the rise of extractions. Unfortunately, machines that require sprays can contaminate and destroy your Kief, therefore making it virtually useless.

Thankfully, CenturionPro uses a non-stick Quantanium coating on the tumblers. This means no spray is needed so your Kief remains 100% pure and usable. To further benefit growers, we developed a new double-bag filtration system. This system will assist with Kief collection, separating it from your trim. This allows you to safely and easily collect the precious trichomes for further processing and profits.

With your machine, you will see that you have a black mesh bag and a white nylon bag. The black bag is the new inner bag and the white bag is your new outer bag.

HOW IT WORKS

- STEP 1** The green leafy trim will collect in the new inner black bag.
- STEP 2** Only the Kief makes it through the black bag and collects in the outer mesh bag.
- STEP 3** The 2 bags are combined to collect and separate both the leafy trim and Kief.
- STEP 4** Turn off the machine and remove the inner bag and then extract Kief. ENJOY!



The bags are easy to wash with a pressure washer using cold water. The bags can also be put through the washing machine, but it is recommended to be run through on a cold delicate cycle only.

LEAF COLLECTOR ASSEMBLY

110V North America
220V Australia EU

STEP 1
ATTACH BAG
SYSTEM TO LEAF
COLLECTOR

Secure with one 4" hose clamp

Secure with 4" Hose Clamps

4" Flex Hose

STEP 2
ATTACH 4" FLEX
HOSE TO THE
DIVERTER AND
ORIGINAL OR
SILVER BULLET

Secure with 4" hose clamps



Leaf Collector Bag System

Requires Cleaning
See Page 11

Zipper



Leaf Collector

Requires Cleaning
See Page 11



CENTURIONPRO

ELITE TRIMMING TECHNOLOGIES



HOPPER ASSEMBLY

**STEP 1
ASSEMBLE
THE FRAME**

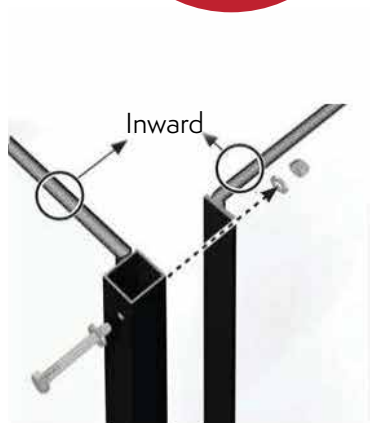

Ensure the RODS are facing inward. Secure with 1/4" BOLTS, WASHERS & LOCKING NUTS

**STEP 2
SECURE THE
HOPPER BAG TO
THE FRAME**

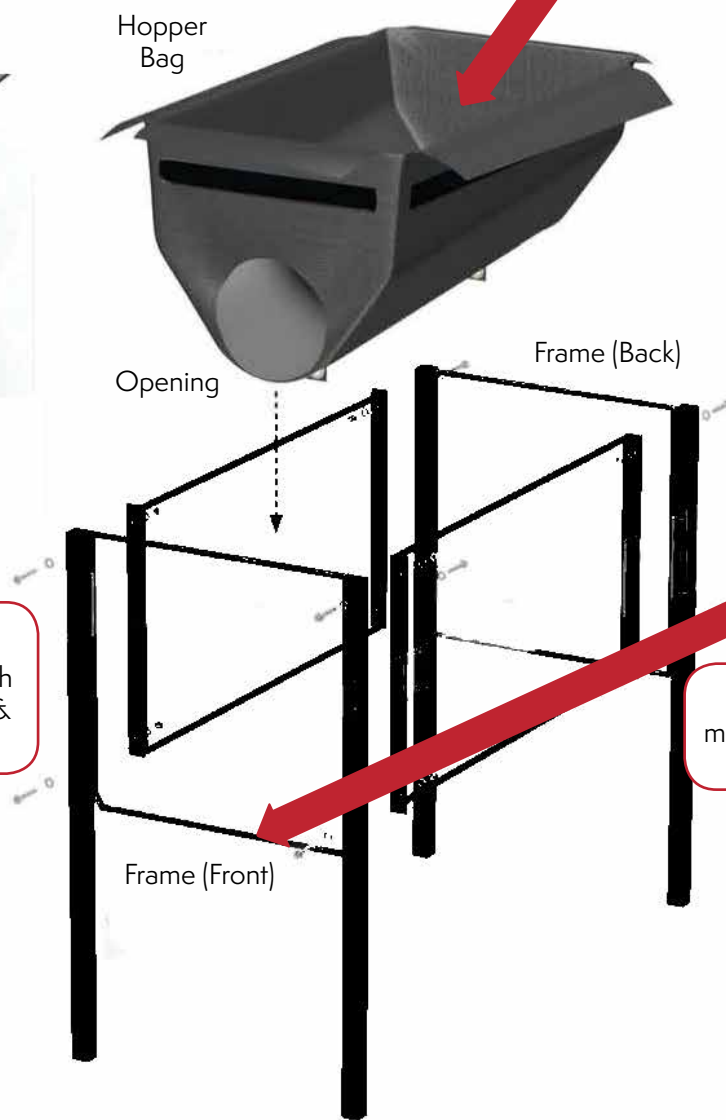

Ensure the OPENING and FRAME (front) match

**STEP 3
CONNECT THE
HOPPER TO THE
MACHINE**

Ensure the Frame and OPENING match the ORIGINAL & SILVER BULLET machine exactly

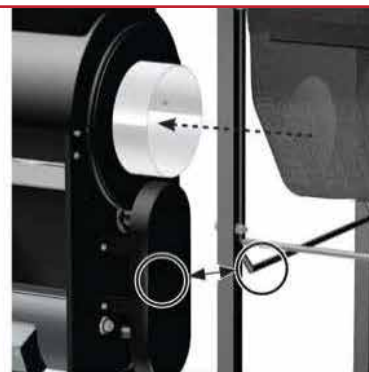

BLADE REMOVAL

For optimal performance and life, the BLADE and the MAGNET BAR must be removed and cleaned every few hours of operation.

IMPORTANT NOTE: Your bed bar blade has been factory set to cut perfectly. Please do not alter the settings of your machine. You might notice slight contact between your rotating cutting reel and the flat bed bar blade - this is normal.



CLEANING THE ORIGINAL & SILVER BULLET

For optimal performance and life, the components must be cleaned every 3 to 4 days of use.

Clean with pressure-washer at 1500-2000 PSI.
Hot water, fan spray setting.

Run the Original or Silver Bullet for 15 minutes after washing. Allowing components to dry.



Clean the length of the CUTTING REEL and SHROUD of all debris

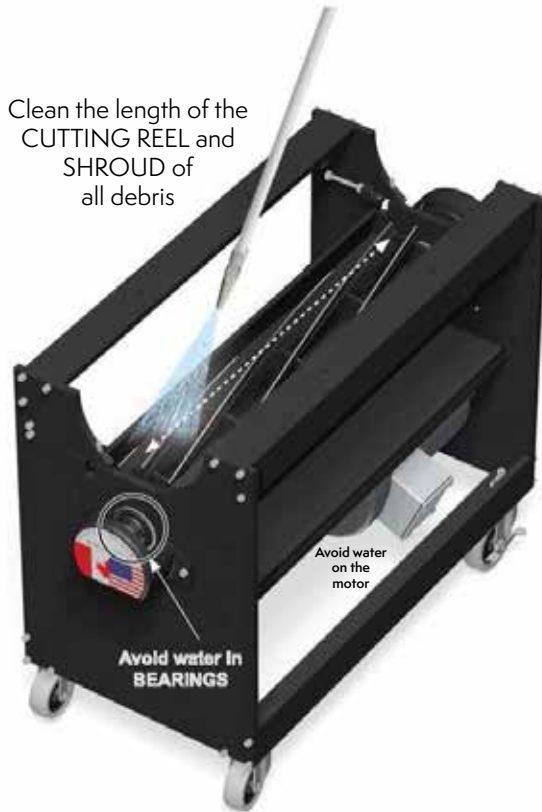

CENTURIONPRO

ELITE TRIMMING TECHNOLOGIES



cprosolutions.com



1 855 535 0558

LEAF COLLECTOR CLEANING

For Optimal performance and life, the LEAF COLLECTOR components must be cleaned every 10 to 20 days of use

INSTRUCTIONS:

Clean with pressure-washing at 1500 - 2000 PSI, Hot Water, Fan Spray Setting. Run LEAF COLLECTOR for 15 minutes after washing, allowing components to dry. Avoid water contact on bearings.

Step 1
REMOVE THE
COVER AND
IMPELLER FROM
THE LEAF
COLLECTOR



When removing the impeller, use a pulling tool only!! DO NOT FORCE THE IMPELLER OUT.

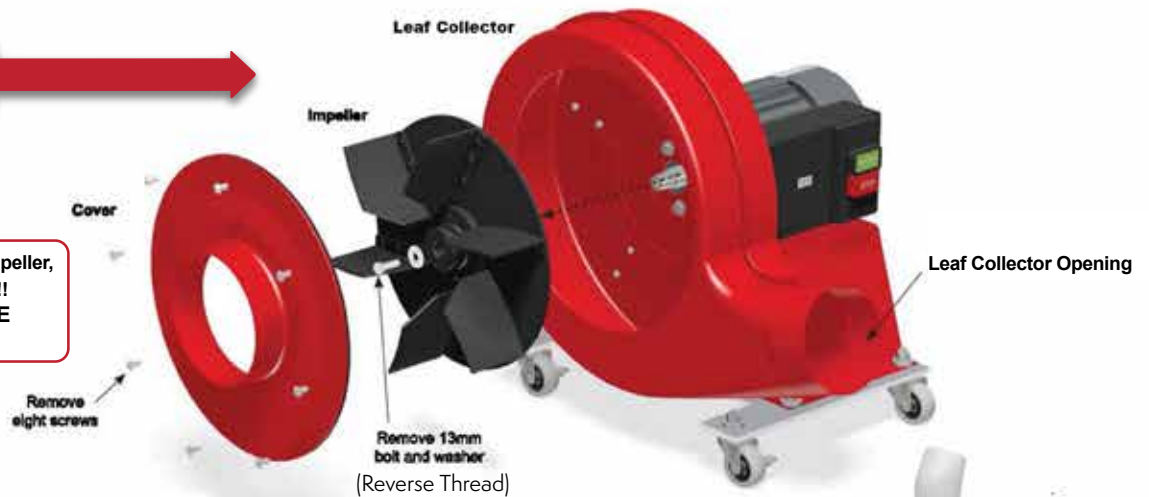

Step 2
PRESSURE WASH
THE IMPELLER AND
THE INTERIOR OF
THE LEAF
COLLECTOR

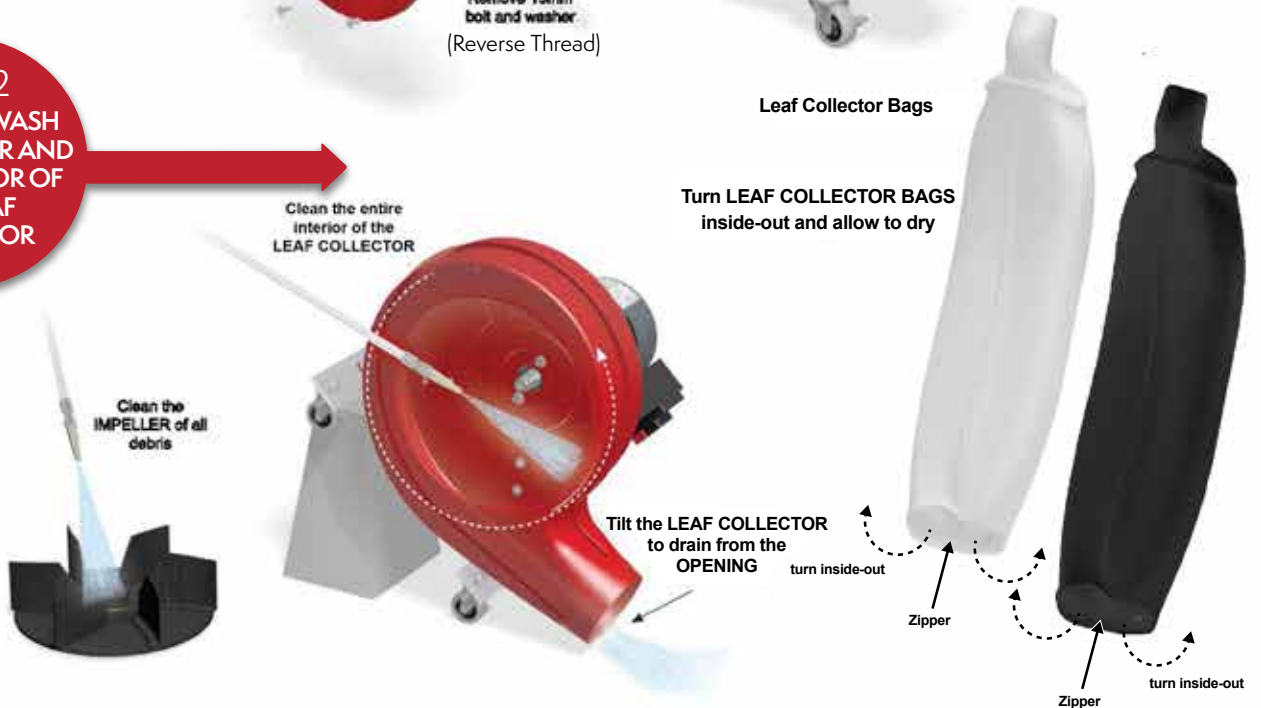

MACHINE MAINTENANCE

The Original & Silver Bullet are precision machines. It is essential that it is operated and maintained with this in mind. The machine has been adjusted and tested by the manufacturer prior to shipping to ensure optimal performance. However, it is important to inspect the machine at initial start-up and after each use to ensure that no damage or plant material build-up has occurred and that the blades spin freely.

In addition, it is highly recommended to clean the machine at the end of every use. This ensures that the blades are kept lubricated and that resin does not build-up and affect performance. This is especially important if the machine has been stored for an extended period of time.

Due to the Quantanium coating on the tumbler, The Original & Silver Bullet do not require any lubricants or sprays. The application of which will only damage or alter the final product and will not assist with the cutting process. In fact, it may hinder it. Cold water is recommended to spray on blades during harvest.



CENTURIONPRO

ELITE TRIMMING TECHNOLOGIES



cprosolutions.com



1 855 535 0558

QUANTANIUM COATED NON-STICK TUMBLER

WHAT IS QUANTANIUM?

Quantanium is a multi-coat non-stick coating that incorporates a unique mix of titanium particles. These particles are blended into the coating that stands up to almost anything and makes the tumbler resistant to scratching. The outstanding release is provided by silicone, not PTFE. All of our Quantanium coated tumblers are made without PTFE/PFOA.



WHY DO WE USE QUANTANIUM?

Higher Potency Harvest

The non-stick properties of the Quantanium tumbler prevents precious trichomes from adhering the tumbler surface without the need for sprays. This results in the end product having a better visual appearance while maintaining its strong natural aroma and flavors. Overall, this results in a better-quality end product as the natural properties are preserved during the harvesting and trimming processes.

Save Time = Save Money

Another benefit of the Quantanium tumbler is that it speeds up the harvesting process since no downtime is required to stop and clean the tumblers throughout the day. A simple whip down with a cloth and warm water will remove the small amount of residue that may be present.

HOW TO CLEAN THE QUANTANIUM TUMBLER

When cleaning the Quantanium tumbler, we recommend that you **DO NOT** pressure wash it. This will cause the coating to flake and come off. Treat the tumbler the same way you would treat a non-stick pan at home by letting it soak in warm, soapy water. After letting it soak, rinse the tumbler and then wipe it with a soft, clean cloth.

In extreme cases, residue can be removed by a thorough cleaning with 3 TBSP of vinegar, 1 TBSP liquid dish detergent and 1 cup of water. Apply with sponge or plastic scrubbing pad, then completely rinse with warm water.

DO NOT use automotive degreasers.

While the Quantanium surface is designed to stand up to rough treatment, non-stick surfaces last longer if you are careful not to rub or touch them with metal surfaces or sharp objects. Remember that sensible care of your Quantanium tumbler will ensure it lasts for many years.

!! IMPORTANT !!

WARRANTY

YOU MUST REGISTER YOUR TRIMMER WITHIN 30 DAYS OF YOUR PURCHASE

You have just made a smart decision by purchasing the best trimmer in the world. Failure to register your machine within 30 days of purchase will void your 10 year warranty. Protect your investment. This process will only take 3 minutes to complete.

TO REGISTER GO TO:
cprosolutions.com/warranty

WARRANTY TERMS & CONDITIONS

CenturionPro Solutions (the manufacturer) will repair or replace, without charge, any parts proven defective in material or workmanship for a period of 10 years on the Trimming Machine and 3 years on the Leaf Collector.

The warranty period will begin on the date the machine(s) is purchased by the initial purchaser. Product or component warranty defects can be remedied at any authorized service dealer, or directly at the manufacturer. Any service work performed, and deemed valid due to a defective part, will be free of charge. CenturionPro Solutions reserves the right to use any manufacturer-approved replacement part for the warranty repair.

If warranty repair is required, please contact the manufacturer at 1-855-535-0558 or techsupport@cprosolutions.com and provide the following information:

1. Model and serial number
2. Proof of purchase date
3. A copy of the original Warranty Registration Card or Online Submission
4. Details of the defect or problem (include photos and videos)

The machine or defective part then must be returned to the manufacturer for analysis or replacement at the cost of the owner. Parts deemed to be covered under the warranty will be provided for free excluding shipping costs.

Do not return the machine to the place of purchase for repair or warranty claims, unless you have been authorized by CenturionPro Solutions to do so. The place of purchase can only sell replacement parts and will not repair any warranty issues, unless it is noted as an authorized repair dealer and has been authorized to work on your machine.

You may be denied warranty coverage if your machine has failed due to any of the following:

- Product abuse
- Product neglect
- Improper maintenance
- Improper electrical connection
- Normal wear
- Accidental damage
- Unapproved modifications

The manufacturer assumes no risk and shall be subject to no liability for damages or loss resulting from the specific use or application made of the product. In no event will the manufacturer be liable for any special, incidental or consequential damages (including loss of use, loss of profit and claims of third parties) however caused - whether by negligence of the manufacturer or otherwise. If you have any questions regarding your warranty rights and responsibilities, please contact the manufacturer.

CenturionPro trimming machines are intended for use on legal aromatic herbs and hops. Please check all municipal, provincial/ state and federal laws and regulations before using these machines. CenturionPro Solutions does not promote or condone the use of these products in any way that may be deemed illegal. Allow only persons who understand this disclaimer to operate the machines.



CENTURIONPRO

ELITE TRIMMING TECHNOLOGIES



FREQUENTLY ASKED QUESTIONS

HOW EASY IS IT TO CLEAN?

Our machines can be taken apart and cleaned within 10-15 minutes. There are four screws to remove the top cover, pressure wash the machine and then you're good to go. Our Quantanium coating is similar to a Teflon pan you would have at home which is even easier to clean. Just submerge in warm water, let soak and then wipe with a soft cloth. We recommend to clean every 4-6 hours of use, but it depends on your strain. We know the importance of down time during a harvest so we wanted to make this process extremely quick and easy.

WHAT IS THE MAINTENANCE LIKE?

We have 15 video tutorials on our website with how to fully service your machine. These step by step videos make it very easy to do everything that will be necessary to maintaining your machine. All parts can be ordered right through the website and will be delivered to you within days.

DO YOUR MACHINES TRIM WET OR DRY?

Our trimmers have the capability of doing both. We offer wet tumblers for wet trimming and dry tumblers for dry trimming. This is a major benefit because you can purchase one machine, with an additional tumbler and now you have the capability to trim wet or dry flowers. Our dry tumblers have a smaller cutting surface than the wet. If you were to run dry product through a wet tumbler, you would have excess loss of flowers. Keeping the yield high is the biggest advantage to having a specific tumbler for both methods of harvesting, wet or dry.

ARE YOUR MACHINES BUILT TO AN INDUSTRIAL STANDARD?

We do not compromise quality for cost savings. All CenturionPro Solutions machines are composed of the highest quality materials available in North America and each machine is put through a comprehensive quality control inspection. We only use brand name components in the build out of our machines which enables us to have the comfort in giving you a 10 year warranty. With proper maintenance these machines will last you well over a decade.

WHAT IS THE OPTIMAL ROOM TEMPERATURE TO TRIM?

Use your CenturionPro machine in 50-60 °F (10- 15 °C) room to get the best performance. Cooler temperatures prevent excessive sticking to machine components.

MY MACHINE IS NOT WORKING LIKE IT DID WHEN IT WAS NEW, WHY?

Make sure to fully clean the machine and blades. If the machine is clean, the blade is adjusted properly and the leaf collector has full suction, then you machine should trim exactly like it was new.

MY PRODUCT IS NOT MOVING THROUGH THE TUMBLER, WHY?

You need to consistently feed the tumbler so it is about 50%-60% full at all times. If the product won't pass through, try taking the plastic top cover off and you should instantly see it begin exiting the tumbler. You can also prop the back wheels up a bit to increase the angle the machine is on. Some strains are heavier and will need more of an angle to exit.

WHY IS MY PRODUCT STICKING TO THE INSIDE OF THE TUMBLER?

If you find that product is sticking inside the tumbler, first clean the tumbler. When you reassemble it, make sure the top brush bristles are poking through 1/4" into the tumbler.

HOW MUCH PRODUCT SHOULD BE IN THE TUMBLER AT ONE TIME?

The tumbler should be 50-60% full when trimming.

ADDITIONAL ASSISTANCE

You are about to enjoy the experience of CenturionPro Solution's automated trimming machine.

For critical information on assembly, cleaning, care, maintenance and how to operate your machine correctly, please review this manual and check out our video tutorials, which are posted on our website for your ease and convenience.

Go to www.cprosolutions.com/video-tutorials for our video tutorials.

These tutorials provide how-to assistance on the following aspects of machine maintenance:

- Straightening the Tumbler/Drum
- Skirt Assembly
- Removing and Replacing The Belt
- Replacing The Motor
- Blade Removal and Cleaning
- Complete Unit Assembly
- Replacing the Bearings
- Bucking Your Product
- Trimmer Cleaning and Maintenance
- Replacing The Tumbler/Drum Ring
- Sharpening The Blade
- Cleaning The Blower
- Adjusting The Blade
- Packing The Bearings
- Replacing The Pulleys

If for some reason you can't find an answer to your question online or in your manual, please do not hesitate to contact us.

We are open Monday through Friday from 9AM to 5PM PST.

Phone: 1-855-535-0558

Filling out the "Contact Us" form on the website, is another sure way to get in touch.



CENTURIONPRO

ELITE TRIMMING TECHNOLOGIES



[cprosolutions.com](http://www.cprosolutions.com)



1 855 535 0558

ORIGINAL & SILVER BULLET MACHINE AND LEAF COLLECTOR SPECIFICATIONS

ORIGINAL & SILVER BULLET TRIMMER

Input Voltage	7 Amp - 110V NA 3.5 Amp - 220V EU/AUS
Dimensions	30" L x 13" W x 28" H
Weight	90 lbs
Reels	1
Blades Per Reel	11
Cuts Per Minute	37,500
Tumbler Diameter	6.5"
Number of Tumblers	x1
Human Trimmer Replacement	20 people
Processing Capacity	Dry: 16-20 lbs/hr Wet: 80-100 lbs/hr
Warranty	10 year

ORIGINAL & SILVER BULLET LEAF COLLECTOR

Input Voltage	15Amp - 220V NA/ EU/AUS
Dimensions	18.5" L x 20" W x 20" H
Weight	70 lbs
Horsepower	3 hp
Airflow Capacity	2750 CFM
Warranty	3 year



CENTURIONPRO

ELITE TRIMMING TECHNOLOGIES



cprosolutions.com



1 855 535 0558



info@cprosolutions.com